

PUBLISHED
JULY 13, 1943.
BY A. P. C.

M. MAUL
PRINTING DEVICE
Filed Feb. 4, 1939

Serial No.
254,525
15 Sheets-Sheet 1

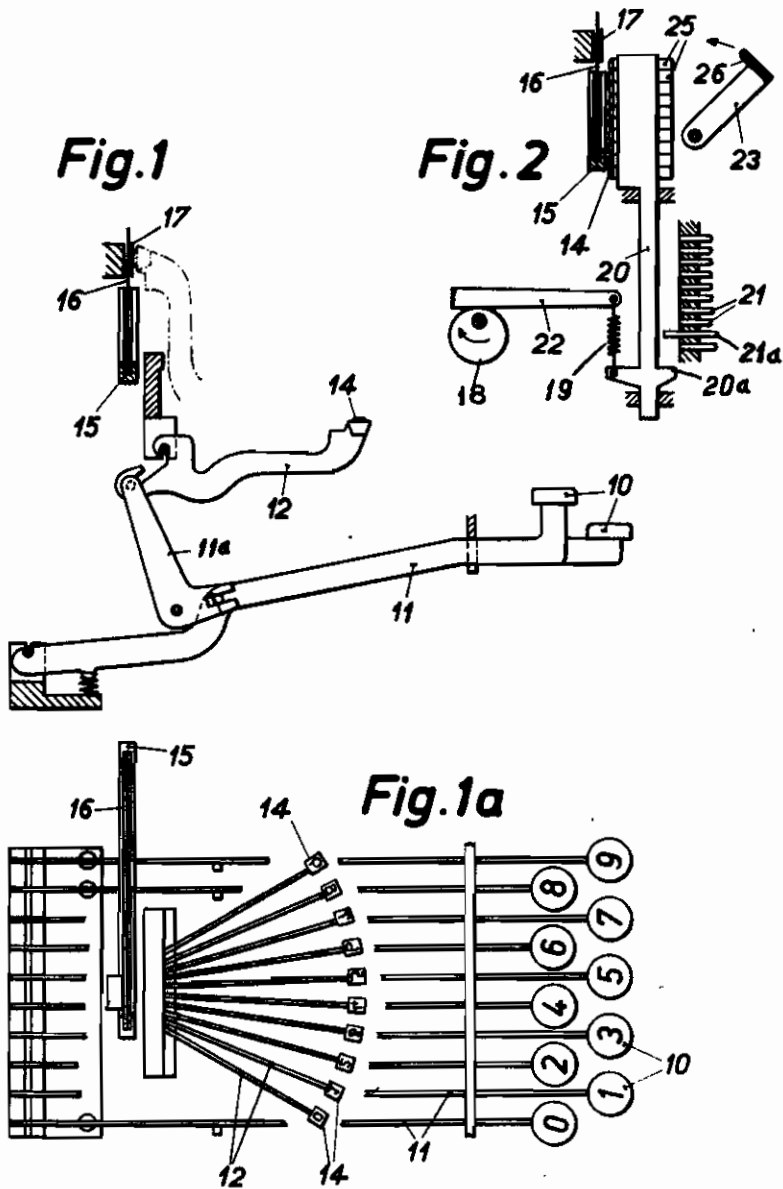

INVENTOR
Michael Maul
BY *W. M. Wilson*
ATTORNEYS

PUBLISHED
JULY 13, 1943.
BY A. P. C.

M. MAUL
PRINTING DEVICE
Filed Feb. 4, 1939

Serial No.
254,525
15 Sheets-Sheet 2

Fig. 3

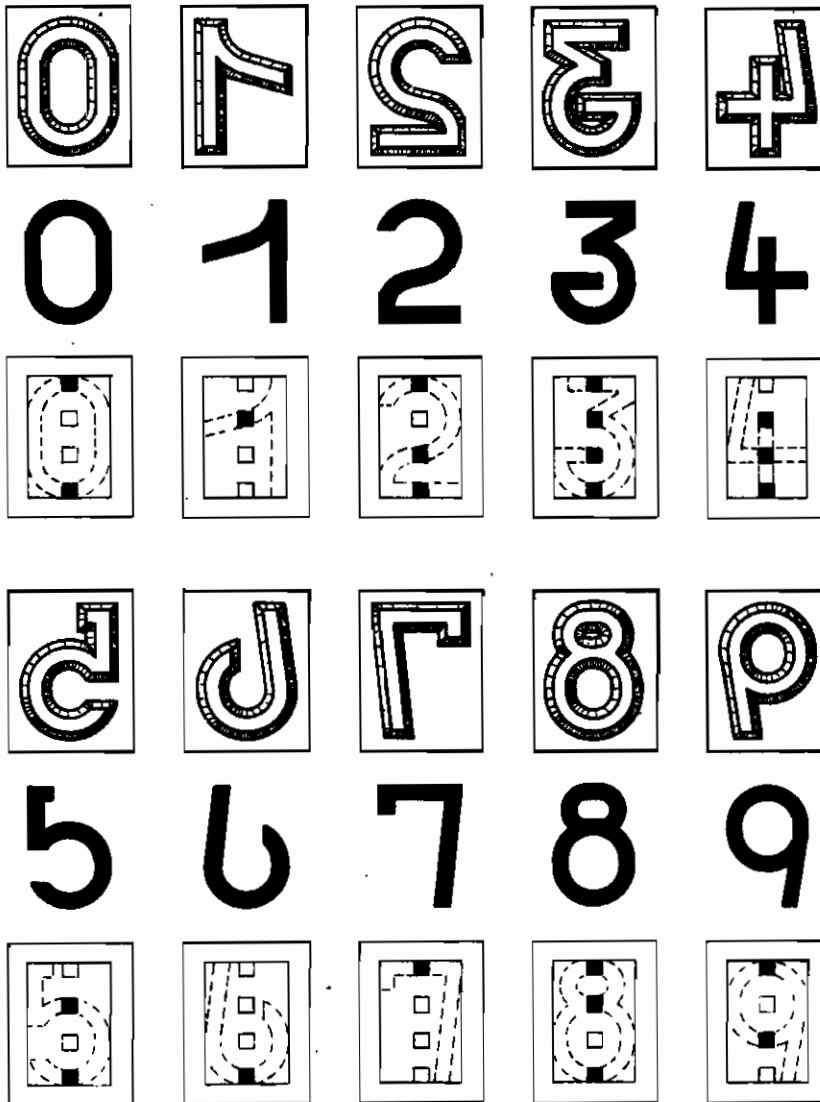

INVENTOR
Michael Maul
BY *W. Wilson*
ATTORNEYS

PUBLISHED
JULY 13, 1943.
BY A. P. C.

M. MAUL
PRINTING DEVICE
Filed Feb. 4, 1939

Serial No.
254,525
15 Sheets-Sheet 3

Fig. 4

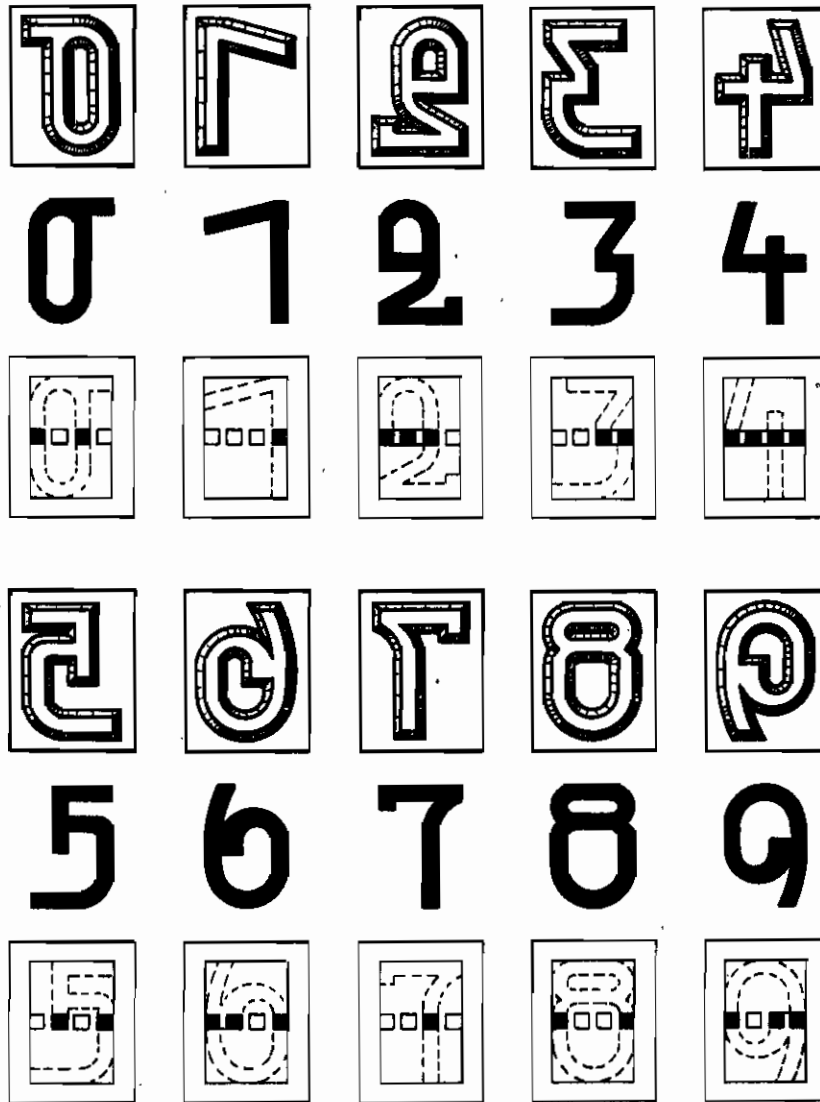

INVENTOR
Michael Maul
BY *W. M. Mahan*
ATTORNEYS

PUBLISHED
JULY 13, 1943.
BY A. P. C.

M. MAUL
PRINTING DEVICE
Filed Feb. 4, 1939

Serial No.
254,525
15 Sheets-Sheet 4

Fig. 5

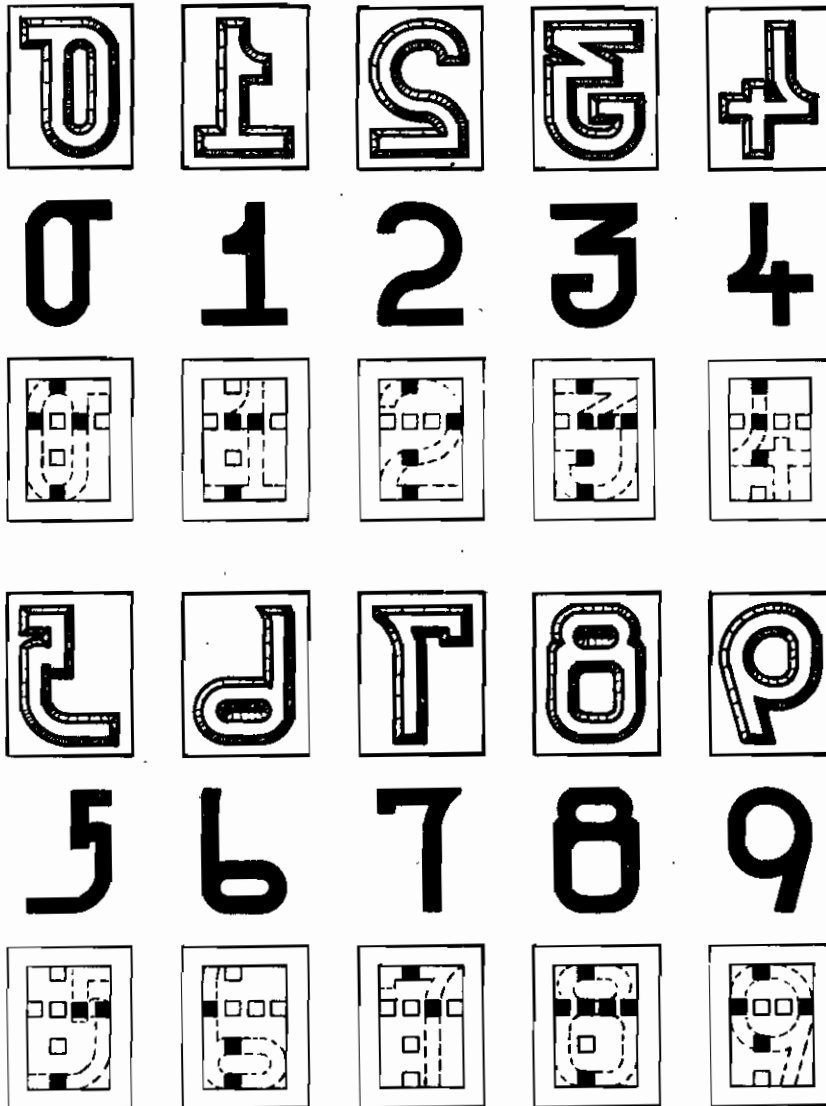

INVENTOR
Michael Maul
BY *W. M. Wilson*
ATTORNEYS

PUBLISHED
JULY 13, 1943.
BY A. P. C.

M. MAUL
PRINTING DEVICE
Filed Feb. 4, 1939

Serial No.
254,525
15 Sheets-Sheet 5

Fig. 6

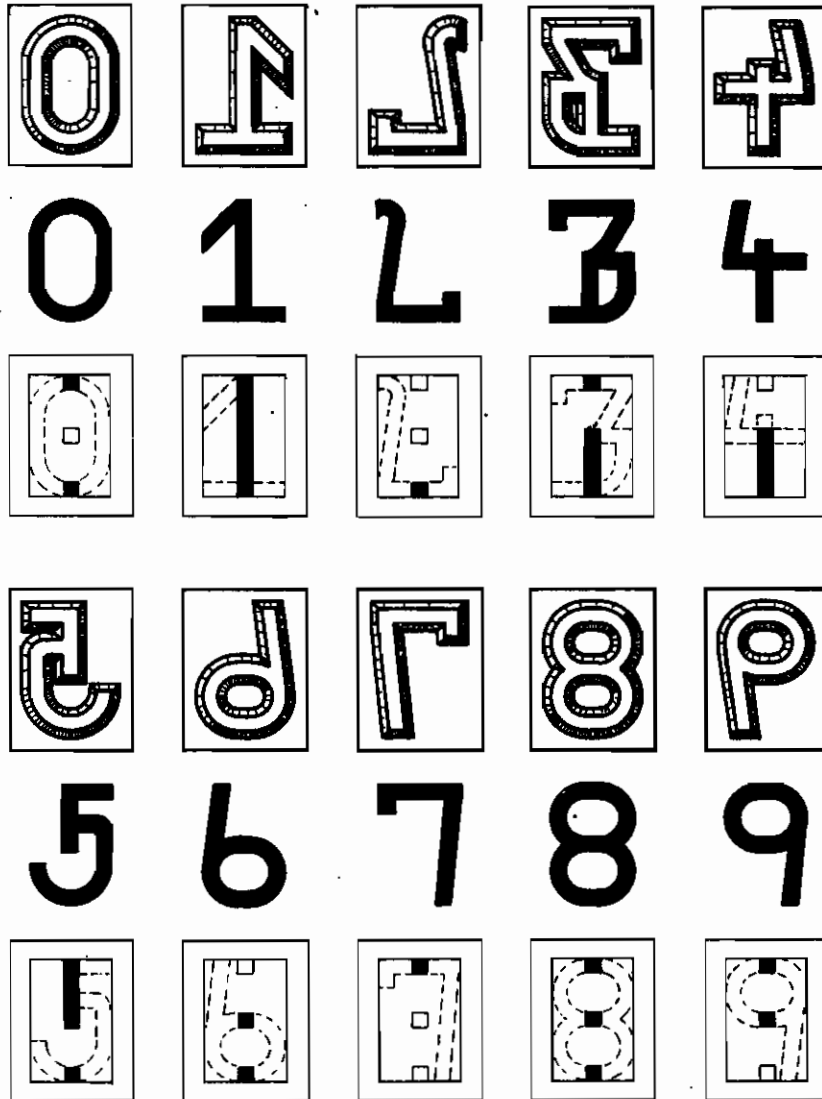

INVENTOR
Michael Maul
BY *Wm. Wilson*
ATTORNEYS

PUBLISHED
JULY 13, 1943.
BY A. P. C.

M. MAUL
PRINTING DEVICE
Filed Feb. 4, 1939

Serial No.
254,525
15 Sheets-Sheet 6

Fig. 7

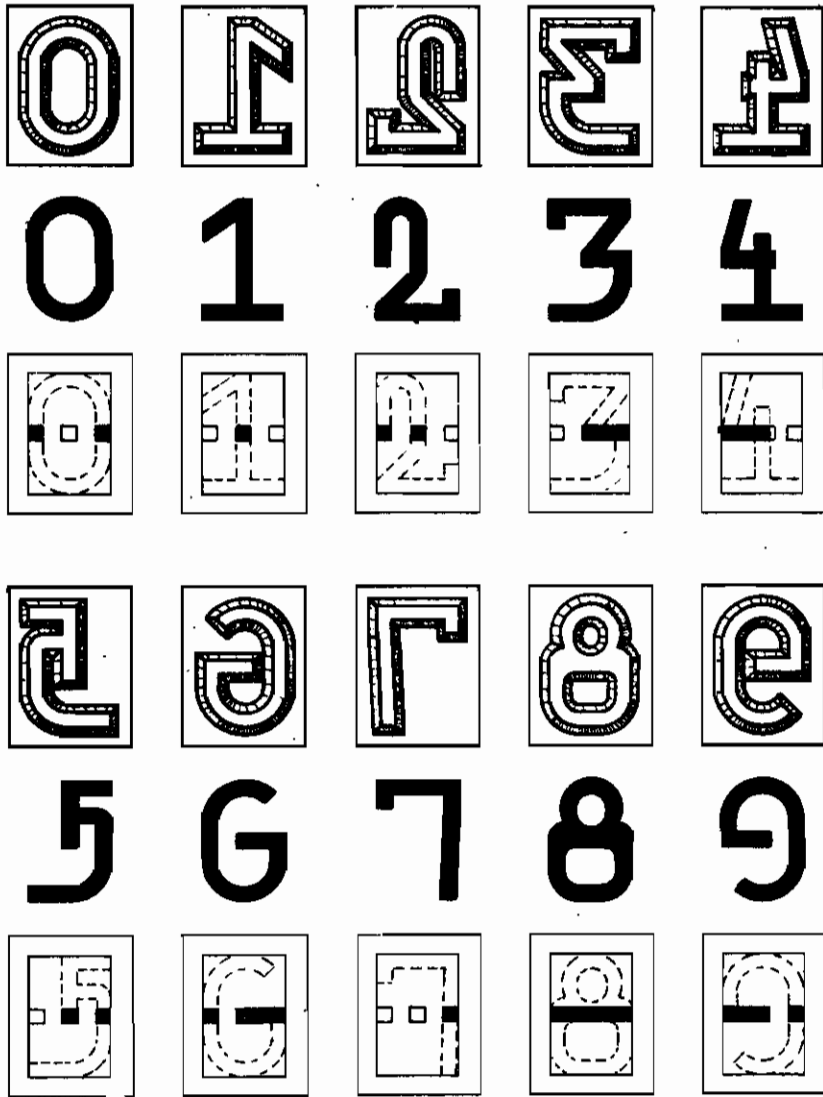

INVENTOR
Michael Maul
BY *W. Wilson*
ATTORNEYS

PUBLISHED
JULY 13, 1943.
BY A. P. C.

M. MAUL
PRINTING DEVICE
Filed Feb. 4, 1939

Serial No.
254,525
15 Sheets-Sheet 7

Fig. 8

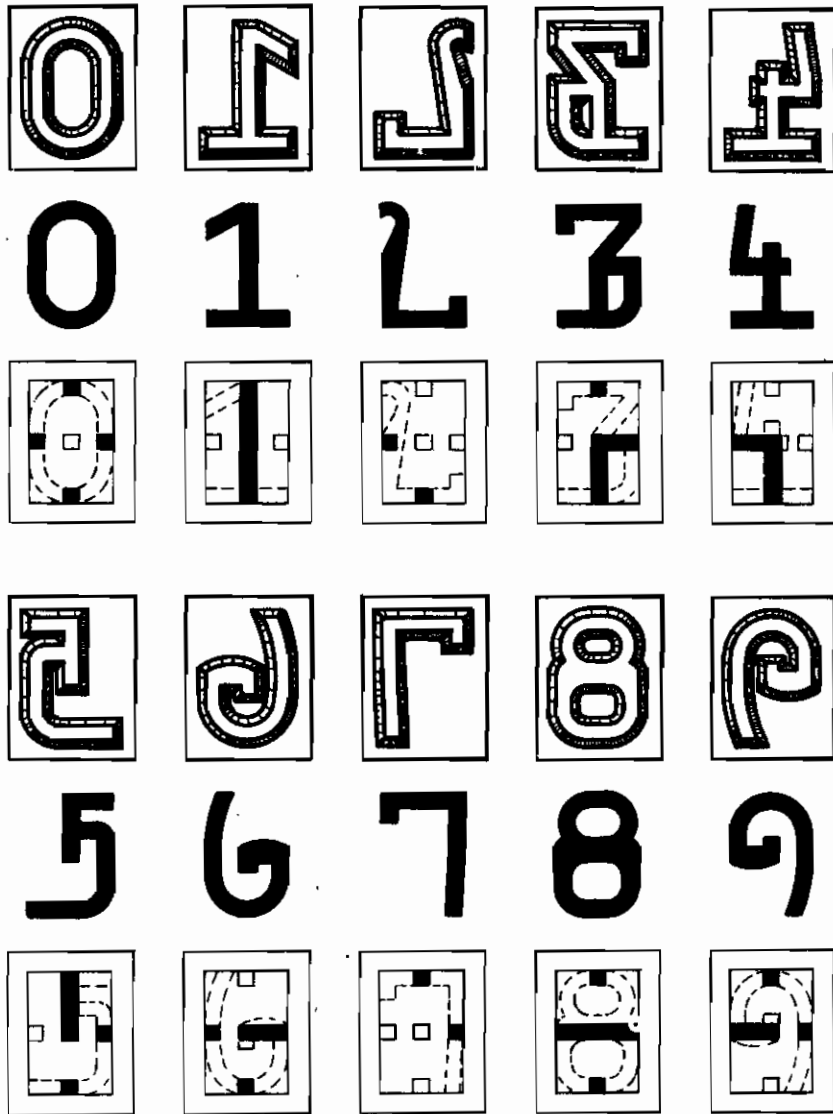

INVENTOR
Michael Maul
BY *W. M. Wilson*
ATTORNEYS

PUBLISHED
JULY 13, 1943.
BY A. P. C.

M. MAUL
PRINTING DEVICE
Filed Feb. 4, 1939

Serial No.
254,525
15 Sheets-Sheet 8

Fig. 9

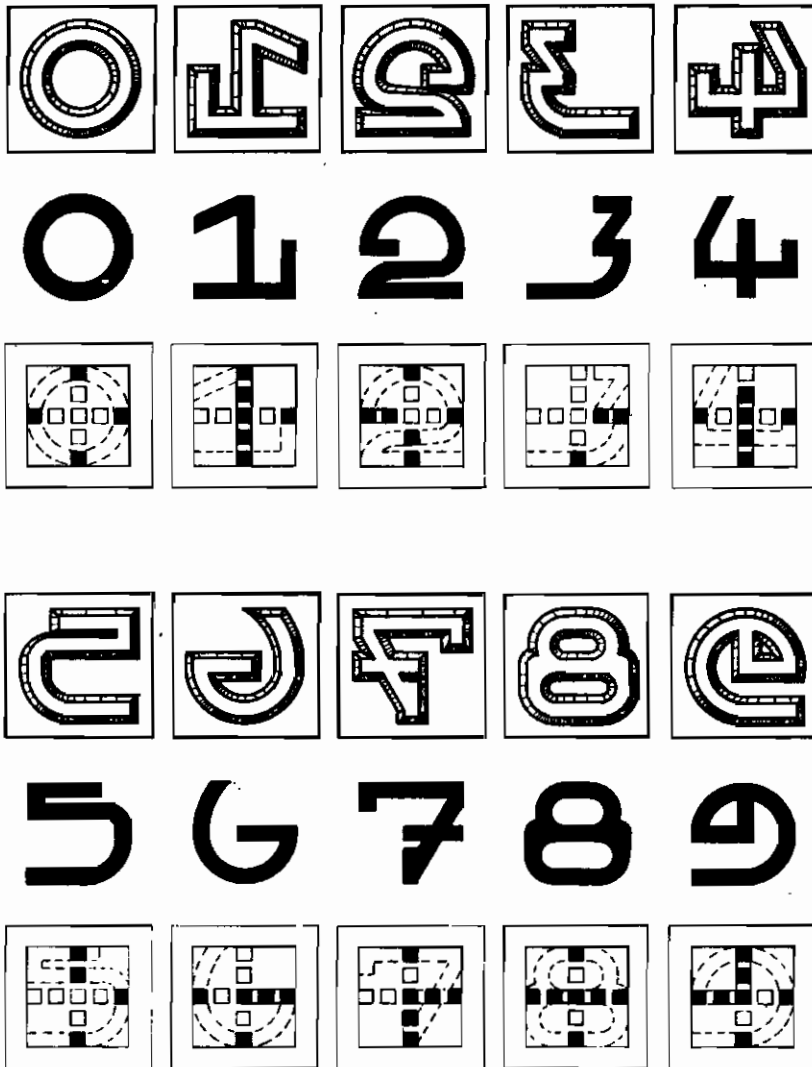

INVENTOR
Michael Maul
BY *W. M. Shaw*
ATTORNEYS

PUBLISHED
JULY 13, 1943.
BY A. P. C.

M. MAUL
PRINTING DEVICE
Filed Feb. 4, 1939

Serial No.
254,525
15 Sheets—Sheet 9

Fig. 10

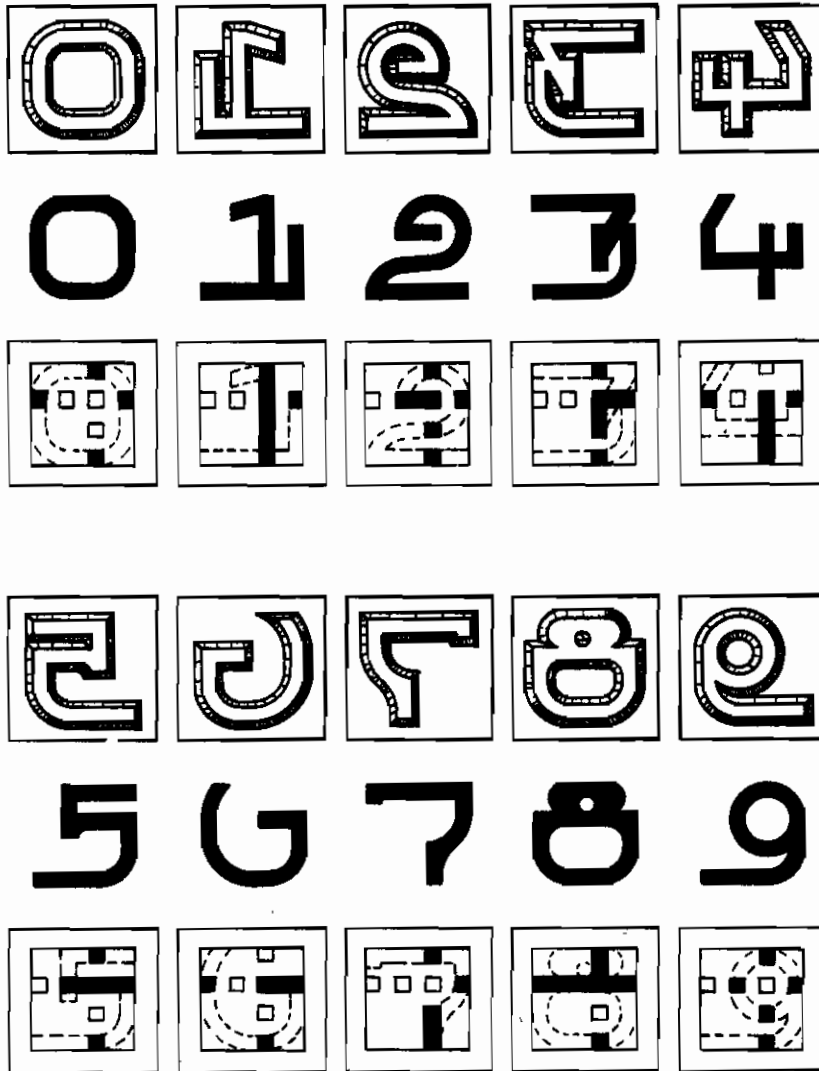

INVENTOR
Michael Maul
BY *W. M. Wilson*
ATTORNEYS

PUBLISHED
JULY 13, 1943.
BY A. P. C.

M. MAUL
PRINTING DEVICE
Filed Feb. 4, 1939

Serial No.
254,525
15 Sheets-Sheet 10

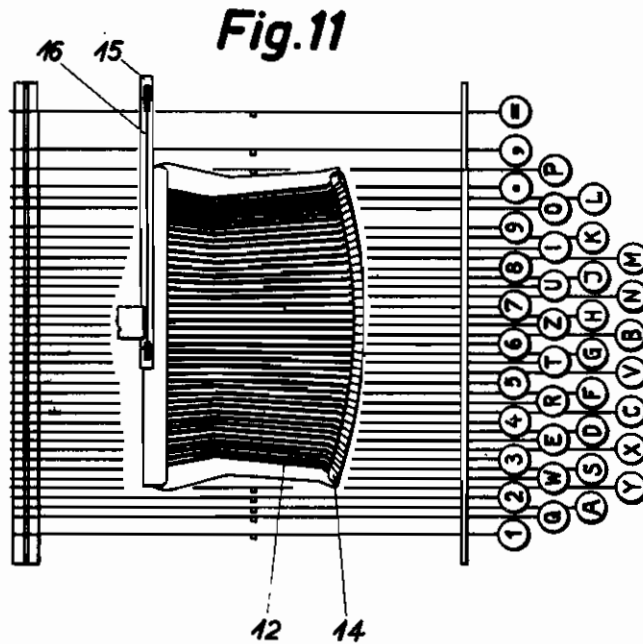
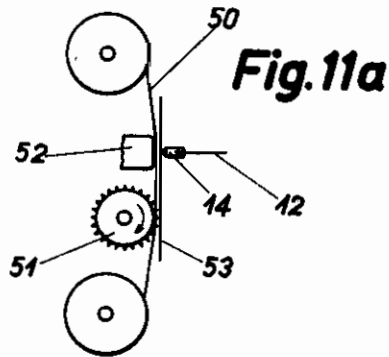

INVENTOR
Michael Maul
BY *W. M. Mahon*
ATTORNEYS

PUBLISHED
JULY 13, 1943.
BY A. P. C.

M. MAUL
PRINTING DEVICE
Filed Feb. 4, 1939

Serial No.
254,525
15 Sheets—Sheet 11

Fig. 12

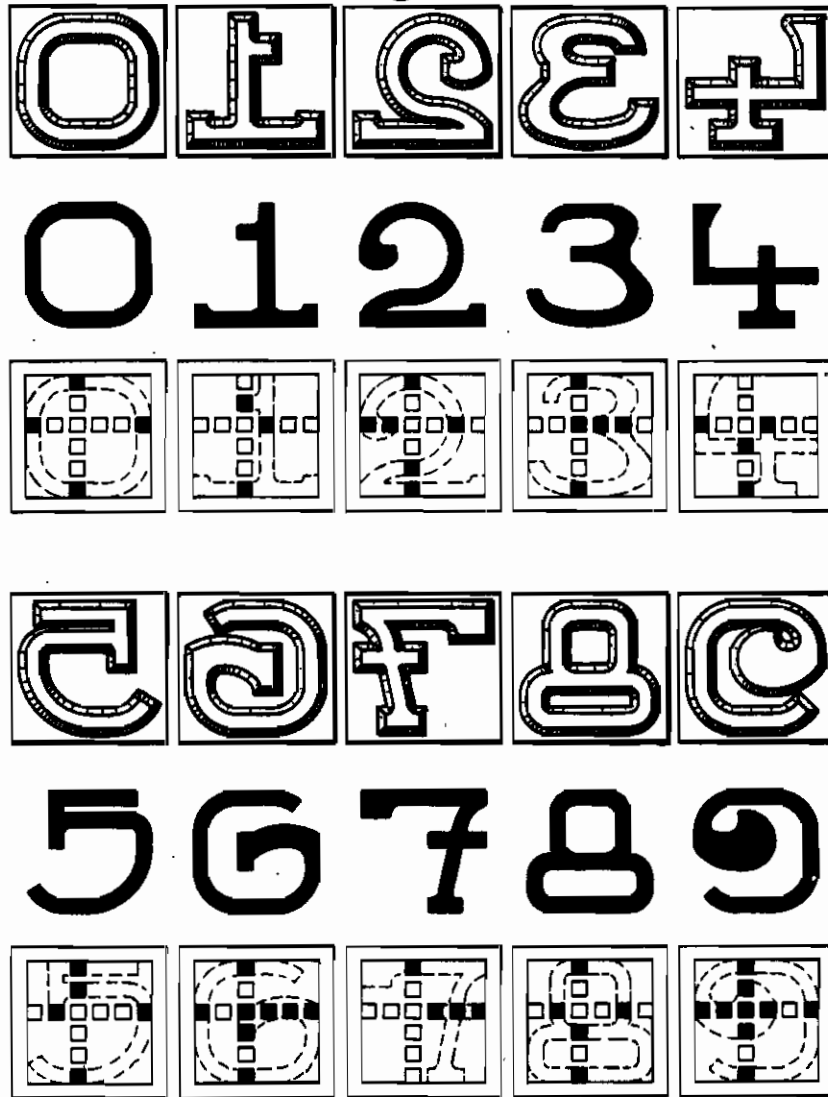

INVENTOR
Michael Maul
BY *W. M. Wilson*
ATTORNEYS

PUBLISHED
JULY 13, 1943.
BY A. P. C.

M. MAUL
PRINTING DEVICE
Filed Feb. 4, 1939

Serial No.
254,525
15 Sheets-Sheet 11

Fig. 12a

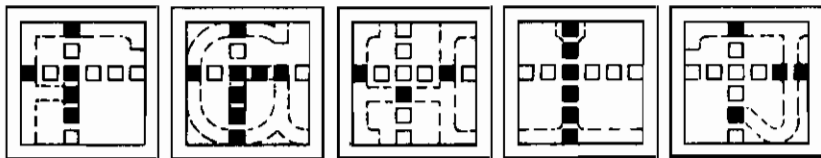
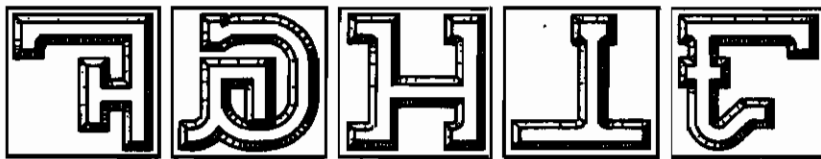
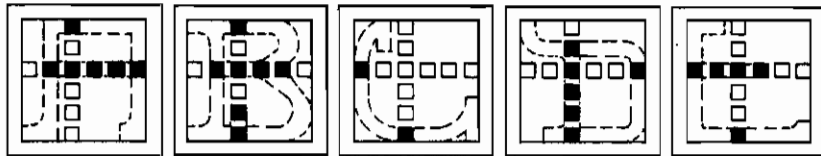
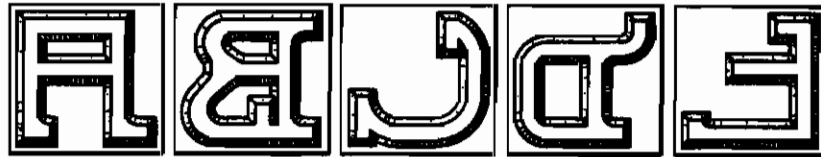

INVENTOR
Michael Maul
BY *W. M. Mahon*
ATTORNEYS

PUBLISHED
JULY 13, 1943.
BY A. P. C.

M. MAUL
PRINTING DEVICE
Filed Feb. 4, 1939

Serial No.
254,525
15 Sheets-Sheet 13

Fig.12b

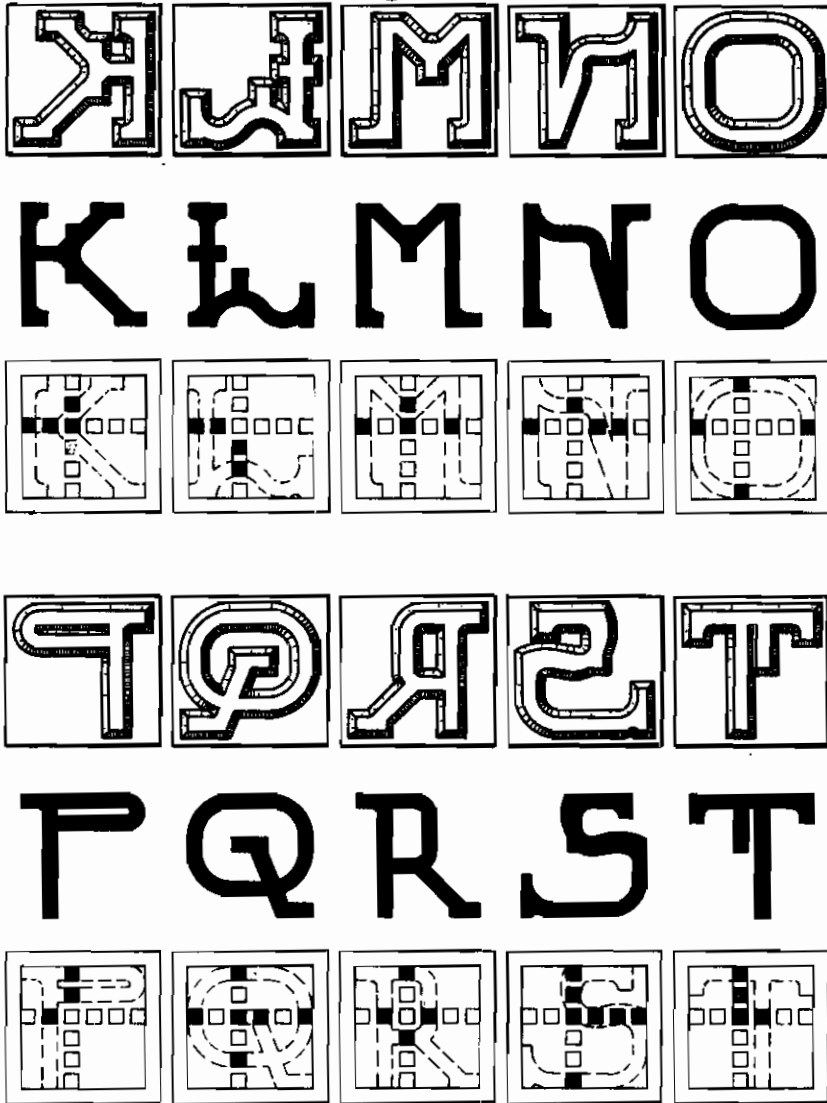

INVENTOR
Michael Maul
BY *W. Malon*
ATTORNEYS

PUBLISHED

JULY 13, 1943.

BY A. P. C.

M. MAUL

PRINTING DEVICE

Filed Feb. 4, 1939

Serial No.

254,525

15 Sheets-Sheet 14

Fig. 12c

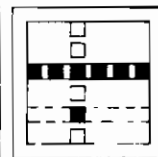
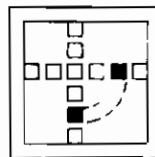
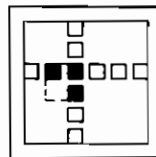
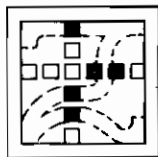
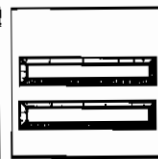
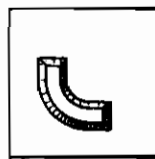
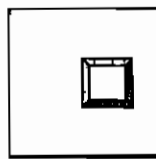
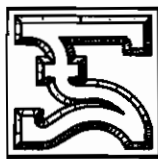
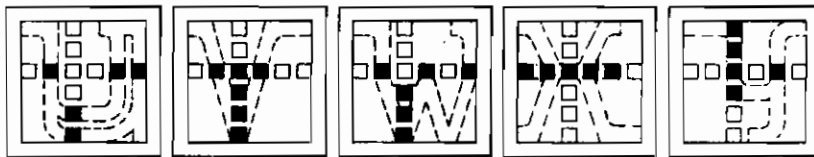

INVENTOR
Michael Maul
BY *W. M. M.*
ATTORNEYS

PUBLISHED
JULY 13, 1943.
BY A. P. C.

M. MAUL
PRINTING DEVICE
Filed Feb. 4, 1939

Serial No.
254,525
15 Sheets-Sheet 18

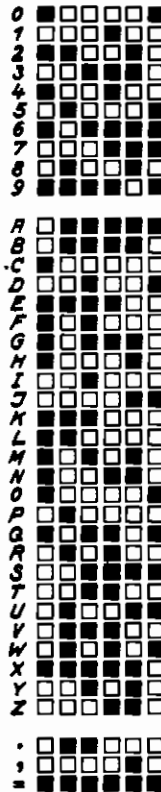

Fig. 13

Fig. 14



INVENTOR
Michael Maul
BY *W. M. Wilson*
ATTORNEYS

ALIEN PROPERTY CUSTODIAN

PRINTING DEVICE

Michael Maul, Berlin-Johannisthal, Germany;
vested in the Alien Property Custodian

Application filed February 4, 1939

The present invention relates to printing devices for data carriers adapted to control machinery and more particularly to such devices having type for forming characters differing in a manner perceivable by machinery.

In technics, compilation of the data of data carriers takes place in several different ways but chiefly in such a way that the data carriers govern the control of machinery in a certain manner. For instance, printing telegraph and type setting machines may be controlled by perforated strips representing the data carriers and upon which the data are symbolically represented by perforations. In other branches of technics the data carriers used for control assume the form of tickets or cards. Compilation of data represented upon cards is necessary to a large extent particularly in bookkeeping and in statistical work, although in this instance the representation of data upon strips has also become known. The compilation of the data may take place in this line of work through assorting according to certain characters or numbers, or by accumulation of the latter, or by some other calculatory compilation or handling of the data. Due to its physical characteristics, the data may cause control of machinery as is done in the known perforated record card system.

Now, it has already been suggested to depart from the perforated card system for the representation of data for the control of machinery by representing the data by graphical characters printed on cards and to use said graphical characters for the direct control of machinery. The use of graphical characters greatly facilitates reading of the data which is to be used for mechanical control. Since the graphical characters must cause a differential control depending upon their meaning, they must also differ in a certain manner perceivable by machinery and the type of a printing device for such graphical characters must be provided accordingly. Among the known suggestions is one according to which each numerical character has one to four predetermined spots to be analyzed in the compilation operation (see U. S. Patent 1,853,443). These spots may be called "index marks" and correspond to identical index marks of the type. The index marks are provided for all characters on predetermined "index positions", in an analogous manner as one speaks of the provision of holes on "hole positions" in the perforated card system. The type of the set of type for printing the characters are so selected that each type shows a different combination of index marks, whereby

the character may be unequivocally determined. In this connection, an index mark combination may include a single mark only. The location of the index positions, which is the same for all type of a set of type, is determined relative to a fixed point, such as the middle of the type plate, or relative to a given bodily edge such as the type lever on which the type is provided. The index positions, properly located, form together the "index position system". Due to the above mentioned differences in the prints obtained by such type, the light electric analysis of the characters and the control of machinery may then be effected in accordance with the meaning of the analyzed characters.

Now, according to the present invention the shape of the printing type is so selected that the index marks of the various type are all on one unequivocally determined straight line. If such type are used, the light electric analysis may be effected in a very simple manner because it is then only necessary to move the printed characters past a light sensitive photo-electric cell. For the compilation of the characters, only a single light electric cell is then necessary. This manner of operation is not possible with the known prints of type since the index marks of the type are arranged arbitrarily within the field circumscribing the type or the printed character respectively.

The printing type according to the invention may also be provided in an advantageous manner in various other ways. In a preferred embodiment the index marks of the printing type are upon the vertical of the printing type. Thus the analysis of characters obtained by such type may be effected in a simple manner by moving the characters in the direction of this vertical line past the light sensitive cell, as analogous to the analysis of perforated record columns in record cards by moving the same past a single analyzing brush.

Now, it is also already known and, for instance, quite usual in telegraphy to analyze the characters of a number or of a word one by one in cross direction of the characters. In the perforated record card system this manner of analysis is known as "cross compilation". In order to permit such cross compilation in a simple manner, the printing type according to the invention may also be provided in such way that the index marks are upon a horizontal of the printing type. A particularly preferred embodiment of the invention will, however, be obtained if the shape of the printing type is so selected that all type of a set of

type have index marks upon a vertical as well as upon a horizontal wherein, of course, the index marks on the vertical as well as the index marks on the horizontal are co-ordinated to a respective index position system within which the type differ by different combinations of index marks. With this embodiment of the invention the type shape is preferably so selected that in certain characters an index mark is present in the crossing point between the vertical and the horizontal and such index mark is common to both index position systems.

Analogous to a known suggestion according to which hole combinations may be formed in a differential manner by points and slots (see for instance U. S. Patent 1,976,352), the index marks in the present invention may be provided as point-like as well as line-like sections of the printing type face so that a characterization of the type by different combinations of index-points and index-lines is obtained. However, this arrangement requires that an index line extends at least over a length corresponding to two index positions. In a further preferred embodiment of the invention, the shape of the printing type is so selected that each printing type has an index-point or index-line on the end of the straight line. In the vertical, preferably the lowermost index-point, and in the horizontal, preferably the index-point at the extreme left is selected for this purpose if the type visible in mirror reading is considered. It is true that this arrangement requires more index positions than the other arrangements, but it affords the advantage that in the analysis of the characters, the first analyzing point corresponds always to an index mark of the type and thereby at the same time the location of the index position system is unequivocally determined.

The safety in the analysis of the characters printed by the type may be considerably increased if between adjacent index marks on the straight line of the type, a distance of at least half of the width of the line of the type is provided. However, a minimum distance corresponding to the whole width of the line of the type is even more desirable. It is not absolutely necessary that all type can be circumscribed by the same figure. Preferably, however, the printing type are so selected that the vertical and the horizontal assumed through the edges of the type of a set of type result in the same figure for each type, for instance, a rectangle or a square. Due to this provision, not only an equal picture of the printed type is obtained, but this circumstance may also be made use of in the analysis of the prints derived from such type to determine the position of the figure circumscribing the type, thereby enabling determination of the location of the straight line of the index position system arranged within said figure.

The above mentioned preferred embodiments may be applied, of course, singly as well as in combination in one and the same set of printing type. It is also quite clear that the invention may be applied in type having different relations between the width and height of the type. In the embodiments still to be described, printing type are shown in which the relation of the height to the width is 3:2 and other type in which the height is about the same as the width.

Provision of type according to the invention may be made in typing and printing mechanisms of various kinds although preferably in such printing devices serving for the preparation of

record cards, tickets, or record strips for the purpose of accounting by machinery, or for telegraph strips. These are only some of the best known possibilities. It is quite obvious that printing may also be effected by hand setting or by a stamp if desired.

It is, therefore, an object of the present invention to provide a printing device for a data carrier adapted for controlling machinery in which type for printing a series of characters is provided with each type having one or more index marks formed by portions of the type face and arranged with the marks in a straight line and in a distinct index mark combination as located with regard to an index position system.

Another object is to provide a printing device having type as described in which the straight line of index marks is either horizontal or vertical.

A further object resides in the provision of a printing device having type as described in which each type has two sets of index marks, one on a horizontal line and one on a vertical line, arranged with respect to two index position systems.

A still further object of the invention is the provision of a printing device having type as described in which each character has an index mark at the same end position of their respective position lines.

It is another object to provide a printing device having type as described in which the configuration of the characters is such that the same size rectangle will be formed by circumscribing any one of the characters with vertical and horizontal lines, the line of index marks being located in the same position on each character relative to the rectangle.

Further objects of the instant invention reside in any novel feature of construction or operation or novel combination of parts present in the embodiment of the invention described and shown in the accompanying drawings whether within or without the scope of the appended claims and irrespective of other specific statements as to the scope of the invention contained herein.

In the drawings:

Fig. 1 shows diagrammatically a section through a typewriter-like mechanism.

Fig. 1a is a top view of the device of Fig. 1.

Fig. 2 shows diagrammatically a section through a printing device provided with type bars.

Figs. 3 to 10 each show a set of printing type provided in the manner according to the invention, as well as prints of said type and the diagrammatic representation of the index marks of the type in connection with a print.

Fig. 11 shows diagrammatically a top view of a typewriter with numerals and letters.

Fig. 11a shows a diagrammatical representation of a printing device as it is particularly suitable for telegraph strips.

Figs. 12 to 12c show in the same manner of representation as Figs. 3 to 10 a set of 36 characters, namely the 10 numerical characters and the 26 letters which differ from each other by the arrangement of the index marks.

Fig. 13 shows the arrangement of the index marks lying upon the horizontal for the various characters of Figs. 12 to 12c.

Fig. 14 shows the index marks lying upon the vertical of the characters of Figs. 12 to 12c.

In Figs. 1 and 1a a typewriter-like device has been illustrated which is adapted to print numerals only. Accordingly, this device has a set

of numeral keys 10 adapted to actuate the rock levers 12 through key levers 11 and intermediate levers 11a. On the rock levers 12 are provided the type bodies 14 which are shaped in any one of the ways shown in Figs. 3 to 10. In Fig. 1a the type shown in Fig. 5 are fastened upon the type bodies 14. Upon depression of a key, the corresponding type of the type body 14 will be moved, together with the ribbon 17, against the data carrier, provided in the present instance as card 16, and the corresponding numeral will be printed thereupon. The carriage 15 carrying the card 16 is shifted step by step in the manner well known in the typewriter art.

In Fig. 2 a printing device having type bars as often used in adding machines has been illustrated. A series of stops 21 is provided with each stop being movable to the position of 21a by the operation of a corresponding key (not shown). A lever 22 engages cam 18 to be raised thereby and acts through spring 19 to raise type bar 20. Mounted on the upper end of type bar 20 is a series of elements 25 carrying type 14 on their ends for cooperation with a ribbon 17 to print upon a card 16 in carriage 15. Type bar 20 will be raised until portion 20a engages stop 21a to position the desired element 25 for printing by the type carried thereby. Hammer 26, carried on pivoted lever 23, will then be moved to strike the selected element 25 to effect printing of the desired character. Only one type bar may be provided and the carriage 15 in Fig. 2 may be shifted step by step. However, it is also possible (as is known in adding machines) to use a plurality of rows of keys to adjust a plurality of type bars simultaneously to effect printing of several characters.

Figs. 3 to 10 show the printing type in a very much enlarged scale as well as their prints and the index mark arrangement for each printing type. Each figure is shown in two groups, the numerals 0 to 4 and the numerals 5 to 9. The uppermost row shows the printing type which are visible in mirror reading, while the row below shows a print of such type. The third row shows the contour lines of the print which correspond to the edges of the printing type and this row shows further by black square points or rectangular lines the index marks corresponding to the various printing type. The outer casing in the first and third as well as in the fourth and sixth row of each figure corresponds to the contour of the type body 14. In the third and sixth row, horizontals and verticals are shown through the outermost edges of the print indicated in dotted lines and in this row the same rectangle is obtained for each type. For the purpose of representation the straight line of the index position system has not been drawn through the printing type themselves in the first and fourth row, but because it is clearer and easier to understand the straight lines are indicated in the prints shown in the third and sixth row.

In Fig. 3, four index positions are provided lying upon a vertical through the printing type and the smallest distance between the index marks is larger than the width of the line of the type. It may be seen that in this figure, as well as in the following ones for each printing type, a different combination of index marks is obtained by which each printing type is unequivocally determined.

In Fig. 4 the index marks are arranged upon a horizontal and the smallest distance between

the index marks is equal to one half of the width of the line of the printing type.

In Fig. 5, two index position systems are shown the one being on a vertical and the other on a horizontal line. It will be seen that each printing type is characterized by a distinct combination of index marks upon the vertical and another distinct combination of index marks upon the horizontal. The printing type of this sort or the prints obtained thereby are particularly adapted for the selective compilation of the characters using either vertical or horizontal analysis.

While in the printing type shown heretofore four index positions for the index marks are provided, the printing type according to Figs. 6 to 8 are provided with only three index positions occupied by index marks in the form of index-points and index-lines, one index-line extending over a space of two or three index positions. It will be seen that in Fig. 6 different combinations for the numerical type are obtained upon the vertical. In Fig. 7 a system similar to that of Fig. 6 is applied. However, the index marks are provided upon a horizontal. Fig. 8 shows a combination of the index position systems of Figs. 6 and 7, i. e. the printing type has distinct combinations of index-points and index-lines according to the vertical as well as according to the horizontal.

If it is desirable, as indicated hereinbefore, that the first point of a character to be analyzed is always an index point, four index positions are not sufficient for the numerical characters but it is then necessary to use five index positions for the distinct characterization of the characters. It will then be noted that the first index point on the straight line must always be a point on the printing type in each character. Fig. 9 shows a set of printing type in which the vertical as well as the horizontal system includes five index points complying with the requirement that in each character the lowermost point of the vertical line is an index point on the print as is the extreme right end point of the horizontal line (corresponding to the extreme left end point of the type visible in mirror reading).

If, for the conditions assumed in Fig. 9, points and lines are used, the shape of printing type shown in Fig. 10 may be chosen and then only four index positions are necessary, the space of which, however, may also be occupied by lines.

Upon the type bodies 14 of the printing devices diagrammatically shown in Figs. 11 and 11a are the printing type provided shown in an enlarged scale in Figs. 12 to 12c. The type are moved by means of the type levers 12 against the card 16 movable with the carriage 15 (Fig. 11) as has already been explained in connection with Figs. 1 and 1a. Accordingly, in Fig. 11 printing of a record card serving for accounting purposes is assumed.

If the printed characters shown in Figs. 12 to 12c are used for purposes of telegraphy or teletyping, the device shown diagrammatically in Fig. 11a is preferably applied. In this device the strip 50 to be printed is fed step by step by a feed wheel 51. The teeth of feed wheel 51 engage corresponding special perforations in the printing strip and the wheel will feed said strip past the printing platen 52. Adjacent the printing strip 50 is the diagrammatically indicated ribbon 53 against which the type body 14 is rocked by means of the type lever 12. Of course, in a similar manner as in Fig. 11 a number of

type levers and keys corresponding to the number of characters and letters are provided.

In Figs. 12 to 12c the manner of illustration is exactly the same as in Figs. 3 to 10. Since 36 characters are concerned which must be characterized distinctly from each other, at least six index positions are necessary for the index marks. As may be seen the numeral and letter type are so shaped that they all differ from each other with regard to the index marks upon a vertical as well as with regard to the index marks upon a horizontal line. Consequently, compilation of the data in Figs. 12 to 12c may be effected according to either the vertical or the horizontal line of index marks. The three signs; period, comma, and double hyphen are also indicated in Fig. 12c and are characterized by a distinct index marks arrangement.

Fig. 13 shows a record of the index marks arrangement with regard to the horizontal analysis

of the numerals, letters and signs of Figs. 12 to 12c, while Fig. 14 shows the index marks arrangement with regard to the vertical analysis of the same characters. It may be seen from this record that each character is unequivocally determined by the index mark combination on the type line.

While there has been shown and described and pointed out the fundamental novel features of the invention as applied to a single modification, it will be understood that various omissions and substitutions and changes in the form and details of the device illustrated and in its operation may be made by those skilled in the art without departing from the spirit of the invention. It is the intention therefore to be limited only as indicated by the scope of the following claims.

MICHAEL MAUL.